



Australia / New Zealand Wiring Devices

AS/NZS 3112:2000 Plugs and Socket Outlets.

This Standard which was revised in the year 2000, requires all 2 pin and 3 pin plugs up to a rating of 15 Amperes to have insulated „live“ pins, by not later than April 3rd 2005.

The use of insulation on the live portion of pins which do not engage with the contacts of socket outlets, eliminates the following when the plug is partially engaged into the socket:

- the possibility of an infant's fingers contacting live pins
- the possibility of small metal objects falling between the plug and the socket, contacting live pins.

The 10 Ampere Australian plug (AS 3112) is used in Australia, New Zealand, Fiji, and Papua New Guinea. Australia's plug and socket system is described in SAA document AS 3112. The plug face is circular, approximately 40 mm in diameter, and 17 mm (live pin and neutral pin) – 20 mm (earth pin) in length from plug face. Standard plug and socket ratings are 10A, 15A, and 20A at 240V a.c. 50 Hz. A cordset with clear plug is recommended for use on medical equipment in Australia.

Document	Catalog No.	(old P/N)	Description	Weight/ea	VPE/Pack	U/M	EDP-No.
1231	9732		Plug bases for panel or flush mounting, 250V ac				
			Supplied as base mechanism plus front plate. Size: 38mm dia x 25mm deep.				
		38BR* (38/10B)	10A plug base, 3 pin flat, suits panel thickness of 2.5mm, Brown	30 g	250/10	ea	100836
		38BL (38/10E)	10A plug base, 3 pin flat, suits panel thickness of 2.5mm, Black	30 g	250/10	ea	100837
		38WE A2	10A plug base, 3 pin flat, suits panel thickness of 1.5mm, White	30 g	250/10	ea	120368
		38WE (38/10)	10A plug base, 3 pin flat, suits panel thickness of 2.5mm, White	30 g	250/10	ea	100835
		38R WE (38/1RW)	10A plug base, round earth, flat active and neutral, suits panel thickness of 2.5mm, White	30 g	250/10	ea	109445
		38/2R WE (38/2R)	10A plug base, flat earth, round active and neutral, suits panel thickness of 2.5mm, White	30 g	250/10	ea	109446
		38/15BR* (38/15B)	15A plug base, 3 pin flat, suits panel thickness of 2.5mm, Brown	30 g	250/10	ea	100839
		38/15BL A2	15A plug base, 3 pin flat, suits panel thickness of 1.5mm, Black	30 g	250/10	ea	120536
		38/15BL (38/15E)	15A plug base, 3 pin flat, suits panel thickness of 2.5mm, Black	30 g	250/10	ea	100840
		38/15WE A1	15A plug base, 3 pin flat, suits panel thickness of 1.2mm, White	30 g	250/10	ea	120525
		38/15WE A2	15A plug base, 3 pin flat, suits panel thickness of 1.5mm, White	30 g	250/10	ea	120535
		38/15WE (38/15)	15A plug base, 3 pin flat, suits panel thickness of 2.5mm, White	30 g	250/10	ea	100838
		38/20WE (38/20)	20A plug base, 3 pin flat, suits panel thickness of 2.5mm, White	30 g	250/10	ea	100841
		38/25WE (38/25)	25A plug base, 2 pin flat with L earth pin, suits panel thickness of 2.5mm, White	30 g	250/10	ea	109444

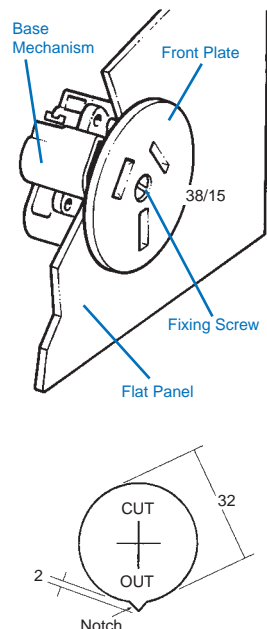

Further items, colors and informations can be found in documents indicated.
* If current stock is depleted, item will be discontinued.

Document	Catalog No.	(old P/N)	Description	Weight/ea	VPE/Pack	U/M	EDP-No.
1231	9732		Plug base and plate assemblies				
			Suits standard mounting accessories. Can be mounted horizontally or vertically. Size: 114 x 70 x 7 mm.				
		38/1WE (38/110)	10A, Catalog No. 38WE plug base on plate, White	61 g	100/10	ea	100889
		38/115WE (38/115)	15A, Catalog No. 38/15WE plug base on plate, White	61 g	100/10	ea	100890
		38/120WE (38/120)	20A, Catalog No. 38/20WE plug base on plate, White	61 g	100/10	ea	100891
		38WE A* (38GF A)	Wallplate only, 114 x 70mm, White	31 g	100	ea	100892

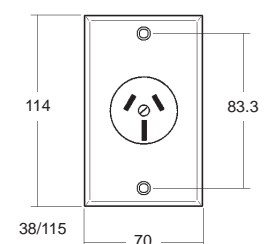

Further items, colors and informations can be found in documents indicated.
* If current stock is depleted, item will be discontinued.

Document	Catalog No.	(old P/N)	Description	Weight/ea	VPE/Pack	U/M	EDP-No.
1233	9731	9732	Large finger-grip, rigid, impact-resistant moulding, 250V ac				

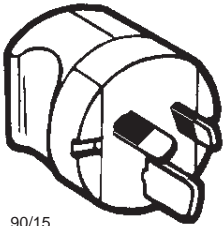

90/15 according current standard: AS/NZS 3112:2000 with insulated pins

			Plug tops according current standard: AS/NZS 3112:2000 with insulated pins.			
90BL	(90/10 BK)	10A plug top, 3 pin flat, Black	35 g	100/10	ea	118216
90GY	(90/10 GY)	10A plug top, 3 pin flat, Grey	35 g	100/10	ea	121075
90WE	(90/10)	10A plug top, 3 pin flat, White	35 g	100/10	ea	121074
90RBL	(90/1R BK)	10A plug top, 3 pin, round earth, flat active and neutral, Black	39 g	100/10	ea	109413
90RGY	(90/1R GY)	10A plug top, 3 pin, round earth, flat active and neutral, Grey	39 g	100/10	ea	109414
90RWE	(90/1R)	10A plug top, 3 pin, round earth, flat active and neutral, White	39 g	100/10	ea	109412
90/2RBL	(90/2R BK)	10A plug top, 3 pin, flat earth, round active and neutral, Black	41 g	100/10	ea	109416
90/2RGY	(90/2R GY)	10A plug top, 3 pin, flat earth, round active and neutral, Grey	41 g	100/10	ea	109417
90/2RWE	(90/2R)	10A plug top, 3 pin, flat earth, round active and neutral, White	41 g	100/10	ea	109415
94WE		10A plug top, 4 pin plug for use with 33 and 34 series. White only	67 g	100/10	ea	110552
90/15BL	(90/15 BK)	15A plug top, 3 pin flat, Black	36 g	100/10	ea	120734
90/15GY	(90/15 GY)	15A plug top, 3 pin flat, Grey	36 g	100/10	ea	121077
90/15WE	(90/15)	15A plug top, 3 pin flat, White	36 g	100/10	ea	121076
90/20BL	(90/20 BK)	20A plug top, 3 pin flat, Black	38 g	100/10	ea	109408
90/20GY	(90/20 GY)	20A plug top, 3 pin flat, Grey	38 g	100/10	ea	121079
90/20WE	(90/20)	20A plug top, 3 pin flat, White	38 g	100/10	ea	109407
90/25BL	(90/25 BK)	25A plug top, 3 pin, L-shaped earth, flat active and neutral, Black	40 g	100/10	ea	109410
90/25GY	(90/25 GY)	25A plug top, 3 pin, L-shaped earth, flat active and neutral, Grey	40 g	100/10	ea	109411
90/25WE	(90/25)	25A plug top, 3 pin, L-shaped earth, flat active and neutral, White	40 g	100/10	ea	109409

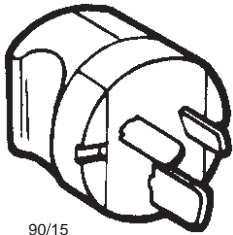

90/15 former standard AS/NZS without insulated pins

Further items, colors and informations can be found in documents indicated.

Former standard AS/NZS without insulated pins available from current stock – if current stock with older versions is depleted, these items will be discontinued.

1233	9731	Large finger grip, rigid, impact resistant moulding, separate cord clamp bar, cord guard, 250V ac					
10WE*	(10/10)	10A extension socket, 3 pin flat, White	55 g	10	ea	100017	
10/15BL*	(10/15BK)	15A extension socket, 3 pin flat, Black	54 g	10	ea	109424	
10/15GY	(10/15GY)	15A extension socket, 3 pin flat, Grey	54 g	100/10	ea	109425	
10/15WE	(10/15)	15A extension socket, 3 pin flat, White	54 g	100/10	ea	100019	

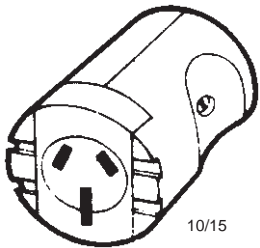

10/15

Further items, colors and informations can be found in documents indicated.
* If current stock is depleted, item will be discontinued.

Plug and pin configurations and dimensions

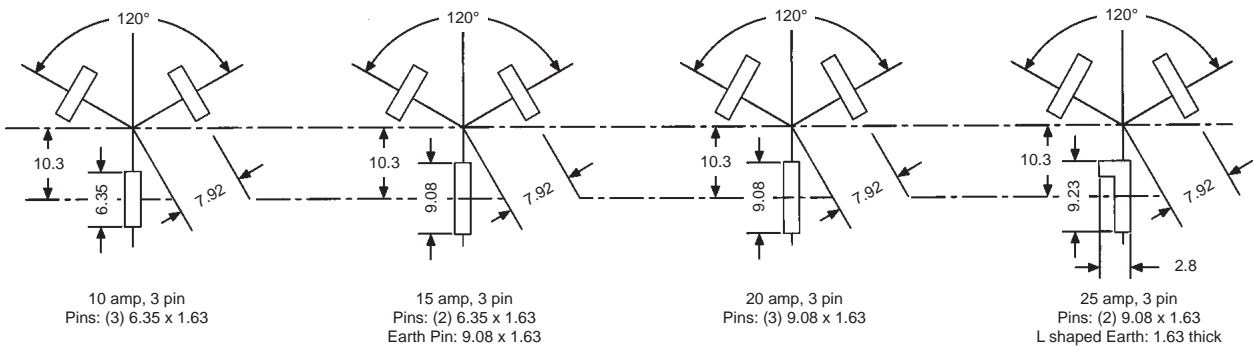

10 amp, 3 pin
Pins: (3) 6.35 x 1.63

15 amp, 3 pin
Pins: (2) 6.35 x 1.63
Earth Pin: 9.08 x 1.63

20 amp, 3 pin
Pins: (3) 9.08 x 1.63

25 amp, 3 pin
Pins: (2) 9.08 x 1.63
L shaped Earth: 1.63 thick

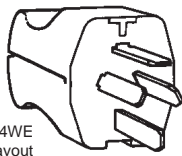

Catalog No. 94WE
pin layout

All diagrams socket front view
All flat pins 1.63 mm thick
All round pins 4.75 mm diameter

120°, 7.92, 10.3 apply to all diagrams.
For dimensions not shown, refer to AS3112.

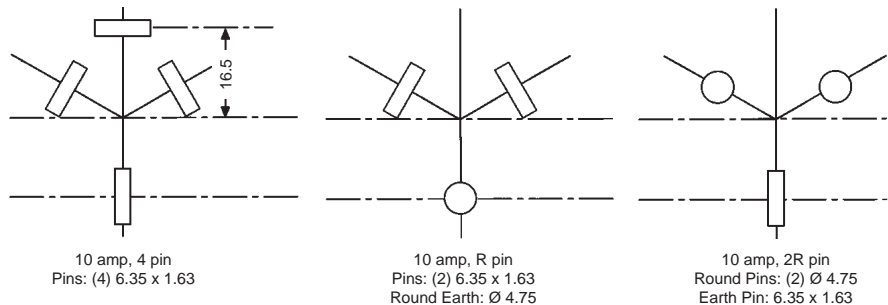

10 amp, 4 pin
Pins: (4) 6.35 x 1.63

10 amp, R pin
Pins: (2) 6.35 x 1.63
Round Earth: Ø 4.75

10 amp, 2R pin
Round Pins: (2) Ø 4.75
Earth Pin: 6.35 x 1.63

Document Catalog No. (old P/N) Description Weight/ea VPE/Pack U/M EDP-No.

1233 9731

Flexible PVC cover with cord locking nut, and screwed clamp terminals, 250V ac

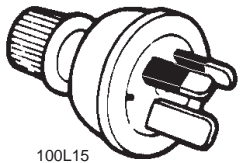

100L15 according current standard: AS/NZS 3112:2000 with insulated pins

Plug tops according current standard: AS/NZS 3112:2000 with insulated pins.

100LBL	(100L10BK)	10A plug top, 3 pin flat, locking nut, 8mm entry hole, Black	29 g	100/10	ea	121081
100LCL	(100L10CL)	10A plug top, 3 pin flat, locking nut, 8mm entry hole, Clear	29 g	100/10	ea	121082
100LGY	(100L10GY)	10A plug top, 3 pin flat, locking nut, 8mm entry hole, Grey	29 g	100/10	ea	109434
100LWE	(100L10)	10A plug top, 3 pin flat, locking nut, 8mm entry hole, White	29 g	100/10	ea	109432
100LHWE		10A plug top, 3 pin flat, 10mm entry hole for heavy duty cord, White	30 g	100/10	ea	121083
100L15BL		15A plug top, 3 pin flat, Black	32 g	100/10	ea	109436
100L15GY		15A plug top, 3 pin flat, Grey	32 g	100/10	ea	109437
100L15WE	(100L15)	15A plug top, 3 pin flat, White	32 g	100/10	ea	109435

Further items, colors and informations can be found in documents indicated.

1233 9731

Flexible PVC cover with safety skirt, cord locking nut and screwed clamp terminals, 250V ac

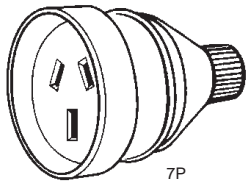

7P

7PBL	(7P10BK)	10A extension socket, 3 pin flat, 8mm entry hole, Black	52 g	100/10	ea	109439
7PGY	(7P10GY)	10A extension socket, 3 pin flat, 8mm entry hole, Grey	52 g	100/10	ea	109440
7PWE	(7P10)	10A extension socket, 3 pin flat, 8mm entry hole, White	52 g	100/10	ea	109438
7P15BL	(7P15BK)	15A extension socket, 3 pin flat, 10mm entry hole, Black	55 g	100/10	ea	109442
7P15GY		15A extension socket, 3 pin flat, 10mm entry hole, Grey	55 g	100/10	ea	109443
7P15WE	(7P15)	15A extension socket, 3 pin flat, 10mm entry hole, White	55 g	100/10	ea	109441

Further items, colors and informations can be found in documents indicated.

9731

Low profile side entry with 45° cord entry and screwed clamp terminals, 250V ac

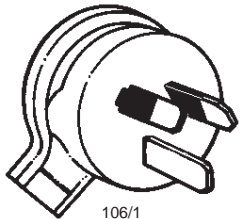

106/1

106/1BL		10A plug top, 3 pin flat., Black	39 g	100/10	ea	121084
106/1GY		10A plug top, 3 pin flat., Grey	39 g	100/10	ea	111570
106/1WE	(106/1)	10A plug top, 3 pin flat., White	39 g	100/10	ea	121085
106/3GY		15A plug top, 3 pin flat, Grey	42 g	100/10	ea	111571
106/4GY		20A plug top, 3 pin flat, Grey	45 g	100/10	ea	111572

Further items, colors and informations can be found in documents indicated.

1235

Plug base, flush, 240V ac



55

Size: 57 x 40 x 29 mm deep. Mounting centres to suit wall box: 84 mm. Mounting centres to fit plate to mech: 60 mm.

55BL*	(55/10BK)	10A, 3 pin plug base mechanism, Black face	54 g	10	ea	115055
55WE*	(55/10)	10A, 3 pin plug base mechanism, White face	54 g	10	ea	101342

Further informations can be found in document indicated.
* If current stock is depleted, item will be discontinued.

1421

Overload protected powerboards, 240V ac

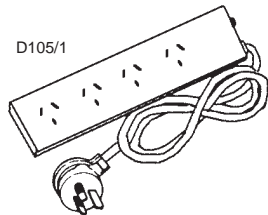

D105/1

All lead lengths are nominal lengths unless otherwise stated

D105		4 outlet powerboard, 0.9m lead, 10A. White	290 g	5	ea	109419
D105/1		4 outlet powerboard, 1.8 m lead, 10A. White	340 g	5	ea	121086
D105/6WE		6 outlet powerboard, 0.9m lead, 10A. White	420 g	5	ea	109418
D105/8OLN		8 outlet powerboard, 1.8m lead, 10A. White	580 g	5	ea	109421
D105/12OL		12 outlet powerboard, 0.9m lead, 10A. White	690 g	2	ea	121087

Further items and informations can be found in documents indicated.

2229 2298 2300

Travel plugs, 2 poles plus earth, Australian pins/socket 10A configuration

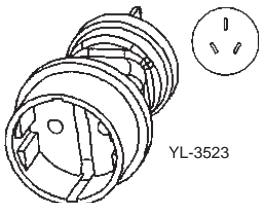

YL-3523

D121A		Adaptor to plug Australian appliances into USA outlets, White	35 g	50/5	ea	120736
D121E		Adaptor to plug Australian appliances into European outlets, White	34 g	50/5	ea	118106
YL-2235		Adaptor to plug Australian appliances into European outlets, Black	74 g	100/10	ea	118681
YL-3523		Adaptor to plug European appliances into Australian outlets, Black	94 g	100/10	ea	118683

Further items and informations can be found in documents indicated.

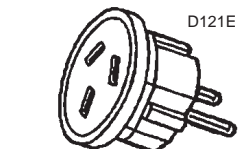

D121E

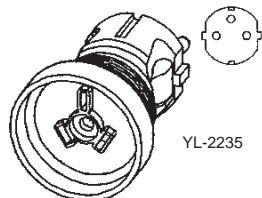

YL-2235

Further international travel plugs and molded YL-Series plug adaptors can be found in Document No. **0950**

Document	Catalog No. (old P/N)	Description	Weight/ea	VPE/Pack	U/M	EDP-No.
----------	-----------------------	-------------	-----------	----------	-----	---------

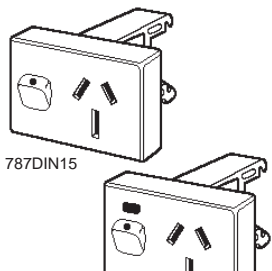
1750 Single powerpoints, DIN rail and panel mounting, 240V ac						
	787DIN	Standard range DIN-mounted powerpoints, 4 modules wide, 53mm projection. 10A single powerpoint with DIN bracket, White	48 g	10	ea	109447
	787DINNS	10A single powerpoint with DIN bracket, neon & safety shutter, White	56 g	10	ea	109448
	787DIN15	15A single powerpoint with DIN bracket, White	49 g	10	ea	109449
	787DINM	10A single powerpoint less DIN bracket, suits panel mounting Cut out 30 x 50 mm with 61.5 mm mounting centres, White	37 g	10	ea	109450

Further informations can be found in document indicated.

DIN Rail - Single Powerpoint

DIN 44 x 67 mm (4 x 18 mm module width) for 53 mm escutcheon.

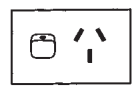

787 DIN
787 DIN M
(Panel mounting)

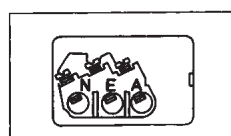

Note: Previous terminal ENA

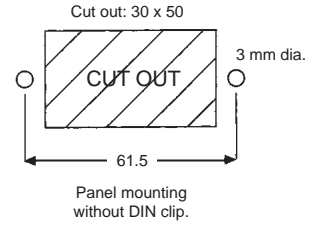
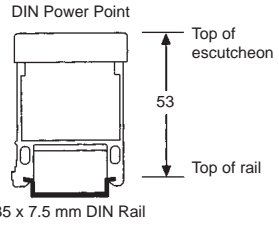

1722 Receptacle for DIN rail mounting, 250V ac						
---	--	--	--	--	--	--

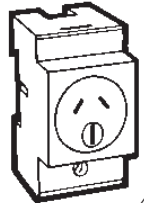
	4SO15D	15A receptacle, encapsulated, 3 pin flat, Brown	120 g	10	ea	107995
	Further informations can be found in document indicated.					

2316 2538 9031 35mm DIN rail mounting modular support mechanisms and snap-in receptacle, 250V ac						
---	--	--	--	--	--	--

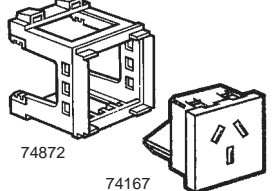
	74167	10A snap-in receptacle module, 3 pin flat, White	33 g	30/10	ea	112913
	74872	Modular Support Mechanisms, 35mm DIN-Rail Mounting, White With this special Modul Support Mechanisms, which clip onto 35mm DIN-Rails, you can easily add a wide range of non-modular types of receptacles to your panel board.	17 g	200/10	ea	112911
Further items, accessories and informations can be found in documents indicated.						

1760 5801 5808 Surface mounting receptacles for wet locations IP 56 (IP 66 with suitable plug), 250V ac						
--	--	--	--	--	--	--

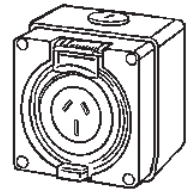
	NOTE: Receptacles supplied without surface box, please order separately.					
	56SO310LE GY	10A surface mounting receptacle without box, 3 pin flat, Grey	174 g	45/1	ea	113151
	56SO315LE GY	15A surface mounting receptacle without box, 3 pin flat, Grey	172 g	45/1	ea	106187
	56E1 GY	1-gang surface mounting box, (102x102x63)mm, Grey	244 g	10/1	ea	106236
	56ES1 GY	1-gang surface mounting box, (102x102x38)mm, Grey	182 g	48/2	ea	111684
	56E2 GY 56E3 GY	2-gang surface mounting box, (198x102x63)mm, Grey 3-gang surface mounting box, (295x102x63)mm, Grey	468 g 711 g	10/1 10/1	ea	111605 119711
Further items, colors and informations can be found in documents indicated.						

5801 5814 5816 Surface mounting combination socket with RCD protection IP 56 (IP 66 with suitable plug), 250V ac						
---	--	--	--	--	--	--

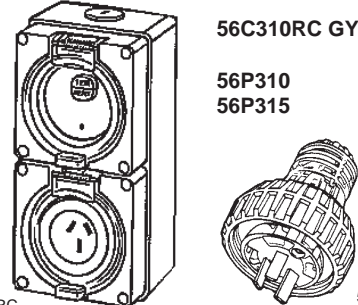
	56C310RC GY	10A surface mounting 30mA RCD protected socket, 3 pin flat, Grey	919 g	120/12	ea	116248
	56P310	10A straight plug, 3 pin flat, with fitted screwed ring to ensure IP66	118 g	50/5	ea	106443
	56P315	15A straight plug, 3 pin flat, with fitted screwed ring to ensure IP66	121 g	50/5	ea	106444
Further items and informations can be found in documents indicated.						

Document	Catalog No.	(old P/N)	Description	Weight/ea	VPE/Pack	U/M	EDP-No.
----------	-------------	-----------	-------------	-----------	----------	-----	---------

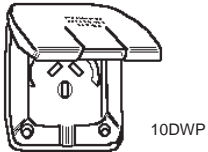
2308 Flush or panel mounting sockets, IP53, 250V ac							
	10DWP BK		10A flush or panel mounting socket with snap cover, 3 pin flat, Black	62 g	20	ea	117804
	10DWP WE		10A flush or panel mounting socket with snap cover, 3 pin flat, White	62 g	20	ea	117805
	10DWP15 WE		15A flush or panel mounting socket with snap cover, 3 pin flat, White	64 g	10	ea	117806
Further informations can be found in document indicated.							

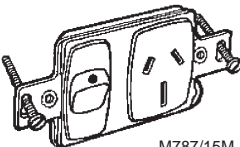
9733 Flush mounting socket mechanisms, 240V ac							
	M787/15M BK		15A horizontal flush mounting mechanisms, 3 pin flat, Black	51 g	10	ea	119083
	Further informations can be found in document indicated.						

9734 Industrial surface mounting devices AZ/NZS 3112, 240V ac, IP66

Industrial Switchgear

Industrial flat pin combination and socket outlet IP 66

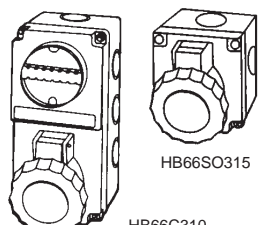
	HB66C310		10A combination, 3 pin flat, 1 pole switch, 1.1kW, Mist Grey/Blue Cover	525 g	1	ea	119873
	HB66SO315		15A surface mounting socket outlet, 3 pin flat, Mist Grey/Blue Cover	300 g	1	ea	119874
Further items and informations can be found in document indicated.							

0960 Australia and New Zealand power supply cords, 250V ac

	8200-25M-BB		10A-250V, 3 x 1.0mm ² Ordinary Duty, PVC Jacketed, Black, 75°C, Color Code CEE, 2.5m, 1st End Plug SAA, 2nd End 50/12mm	280 g	50	ea	118690
	Further items and informations can be found in document indicated.						

0960 Australia and New Zealand power supply cords, 250V ac

	8250-25M-BB		10A-250V, 3 x 1.0mm ² Ordinary Duty, PVC Jacketed, Black, 75°C, Color Code CEE, 2.5m, 1st End Plug SAA, 2nd End IEC 60320/C13	300 g	50	ea	120409
	8250-25M-GG		10A-250V, 3 x 1.0mm ² Ordinary Duty, PVC Jacketed, Grey, 75°C, Color Code CEE, 2.5m, 1st End Plug SAA, 2nd End IEC 60320/C13	300 g	50	ea	120411
	8251-18M-BB		10A-250V, 3 x 0.75mm ² Ordinary Duty, PVC Jacketed, Black, 75°C, Color Code CEE, 2.5m, 1st End Plug SAA, 2nd End IEC 60320/C13	187 g	10	ea	120408
Further items and informations can be found in document indicated.							

0960 Australia and New Zealand power supply cords, 250V ac

	8220-25M-BB		7.5A-250V, 2 x 0.75mm ² Ordinary Duty, PVC Jacketed, Black, 75°C, Color Code CEE, 2.5m, 1st End Plug SAA, 2nd End 50/12mm	200 g	100	ea	120410
	Further items and informations can be found in document indicated.						

To learn more about B-I-A please visit us at our
WEB site: www.BiaGmbH.com

