

XIF/XIFC Explosionproof Internal Flanged Junction Boxes & Control Enclosures

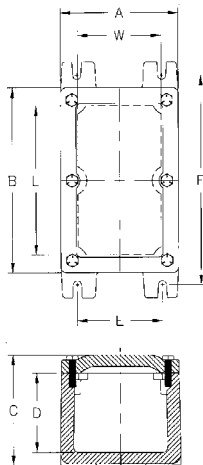

XIF: Junction Boxes XIFC: Control Enclosures



Optional NEMA 4. Add suffix "N4" to catalog number.

Use layout sheet for drilling and tapping specifications.

XIFC Certifications: (N4 Optional)

-  • Class I, Groups C & D
-  • Class II, Groups E, F & G
- Class III
- UL 1203 (Classified)

XIF Compliances:

- NEC Class I, Group D
- Class II, Groups E, F & G
- Class III
- UL Standard 886
- CSA Standard C22.2 No. 30
- For XIF consult factory for specific certifications.

Catalog Number	Inside Nominal Dimensions			Overall Dimensions			Mounting Lug CL to CL		Mounting Bolt Size	Shipping Weight, Pounds	
	W	L	D	A	B	C	E	F			
XIFC 030303	XIF 030303	3 5/16	3 5/16	3 3/16	4 1/2	4 1/2	4 5/16	3 1/4	5 1/2	5/16	5
XIFC 030603	XIF 030603	3 1/4	5 3/4	3	4 1/2	7 1/16	4 1/4	3 1/4	8	5/16	6 1/2
XIFC 030703	XIF 030703	3 1/4	6 7/8	3	4 1/2	8 1/8	4 5/16	3 5/16	9	5/16	7 1/2
XIFC 030903	XIF 030903	3 11/32	8 15/16	3	4 1/2	10 1/16	4 5/16	3 1/4	11	5/16	9 1/2
XIFC 031103	XIF 031103	3 1/4	10 15/16	3	4 1/2	12	4 5/16	3 1/4	13	5/16	11
XIFC 031303	XIF 031303	3 1/4	12 13/16	3	4 1/2	14 1/16	4 5/16	3 1/4	15	5/16	11 1/2
XIFC 031503	XIF 031503	3 1/4	14 3/4	3 1/16	4 1/2	16	4 5/16	3 1/4	17	5/16	13
XIFC 031803	XIF 031803	3 1/4	17 3/4	3	4 1/2	19	4 1/4	3 1/4	20	5/16	16
XIFC 032403	XIF 032403	3 1/4	23 9/16	3	4 1/2	25 1/16	4 5/16	3 1/4	26	5/16	21
XIFC 033003	XIF 033003	3 1/4	29 1/2	3	4 9/16	31 1/16	4 5/16	3 1/4	32 1/8	5/16	28
XIFC 033603	XIF 033603	3 1/4	35 7/16	3	4 1/2	37	4 3/8	3 1/4	38 1/8	5/16	33
XIFC 040604	XIF 040604	4 1/8	5 7/8	4	5 3/8	7	5 5/16	4 3/8	8 1/4	5/16	8 1/2
XIFC 041204	XIF 041204	4 1/4	11 13/16	4	5 1/2	13 1/8	5 5/16	4 3/8	14 1/4	5/16	15 1/2
XIFC 060606	XIF 060606	5 1/2	5 1/2	6	7	7	7 3/8	5 1/2	8 1/2	3/8	14
XIFC 060608	XIF 060608	5 1/4	5 1/2	8	7	7	9 3/8	5 1/2	8 1/2	3/8	17 1/2
XIFC 061206	XIF 061206	5 1/4	11 1/8	6	7 1/4	13 1/2	7 5/8	5 1/2	15	3/8	28
	XIF 061806	6	18	6	7 1/2	19 1/2	7 13/16	5 1/2	21 1/8	3/8	33
	XIF 062406	6	24	6	7 1/2	25 1/2	7 3/4	5 1/2	27	3/8	59
	XIF 063606	6	36	6	7 1/2	37 1/2	7 13/16	5 1/2	39	3/8	84
XIFC 070704	XIF 070704	6 7/8	6 7/8	4	7 15/16	7 15/16	5 5/16	6 5/8	9 1/8	3/8	13
	XIF 071603	7	16	3 1/2	8 1/2	17 1/2	5 5/16	6 1/2	18 7/8	3/8	36
	XIF 083206	8	32	5 7/8	9 1/2	33 1/2	7 7/8	7 1/2	35	3/8	87

Note: All dimensions are in inches and are nominal enclosure size only.

XIF/XIFC Explosionproof Internal Flanged Junction Boxes & Control Enclosures

CUSTOMER DESIGN SHEET

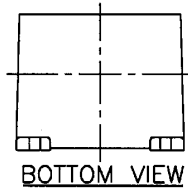
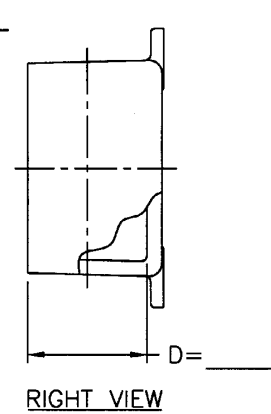
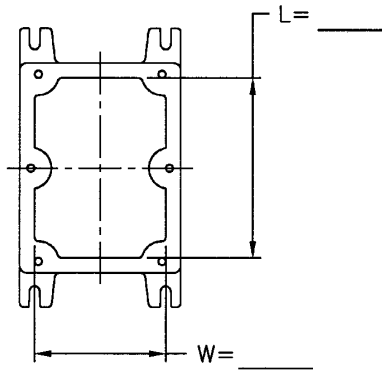
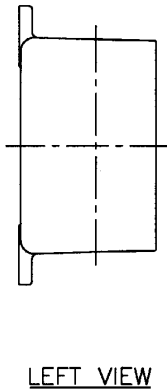
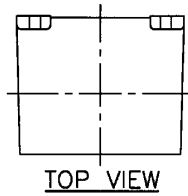

BOX LAYOUT

CAT. # XIF(C) _____

- N4 O-RING
- MOUNTING PAN

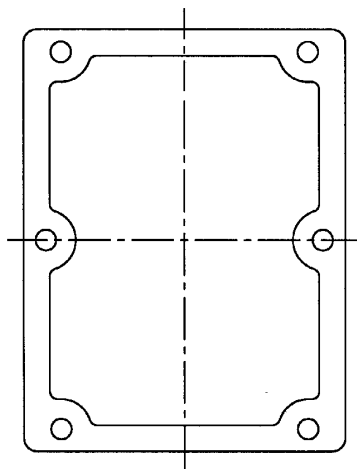

COVER LAYOUT

XIF/XIFC Mounting Pans

MATERIAL — Steel: (XSM)

Galvanized 12 gauge steel plate. The catalog number includes the steel mounting pan complete with 1/4" high spacers and stainless steel mounting screws.

MATERIAL — Aluminum: (XSA)

Consult factory for availability.

MATERIAL — Phenolic: (XSB)

A special phenolic laminated material that has high mechanical and dielectric strength. It is excellent for mounting and wiring control equipment. The catalog number includes the phenolic board, 3/8" thick, complete with 1/4" high spacers and stainless steel mounting screws.

Note: No installation charge when customer specifies factory installation of mounting pan.

Catalog Number (Steel)	Catalog Number (Aluminum)	Catalog Number (Phenolic)	Pan Dimensions		Enclosure Size Reference Inside Width x Length	Weight Each (pounds) (Steel)
			Width	Length		
XSM 0303	XSA 0303	XSB 0303	3	3	3 x 3	1/4
XSM 0306	XSA 0306	XSB 0306	3	5 1/2	3 x 6	1/2
XSM 0307	XSA 0307	XSB 0307	3	6 1/2	3 x 7	1/2
XSM 0309	XSA 0309	XSB 0309	3	8 1/2	3 x 9	3/4
XSM 0311	XSA 0311	XSB 0311	3	10 1/2	3 x 11	1
XSM 0313	XSA 0313	XSB 0313	3	12 1/2	3 x 13	1 1/4
XSM 0315	XSA 0315	XSB 0315	3	14 1/2	3 x 15	1 1/2
XSM 0318	XSA 0318	XSB 0318	3	17 1/2	3 x 18	1 3/4
XSM 0324	XSA 0324	XSB 0324	3	23 1/2	3 x 24	2 1/4
XSM 0330	XSA 0330	XSB 0330	3	29	3 x 30	2 3/4
XSM 0336	XSA 0336	XSB 0336	3	35	3 x 36	3 1/4
XSM 0406	XSA 0406	XSB 0406	3 7/8	5 1/2	4 x 6	3/4
XSM 0412	XSA 0412	XSB 0412	3 7/8	11 1/2	4 x 12	1 1/2
XSM 0606	XSA 0606	XSB 0606	5 1/2	5 1/2	6 x 6	1
XSM 0612	XSA 0612	XSB 0612	5 1/2	11 1/2	6 x 12	2
XSM 0618	XSA 0618	XSB 0618	5 5/8	16 7/8	6 x 18	3
XSM 0624	XSA 0624	XSB 0624	5 5/8	22 7/8	6 x 24	4
XSM 0636	XSA 0636	XSB 0636	5 5/8	34 7/8	6 x 36	6
XSM 0707	XSA 0707	XSB 0707	6 1/2	6 1/2	7 x 7	1 1/2
XSM 0716	XSA 0716	XSB 0716	6 1/2	15 1/2	7 x 16	3
XSM 0832	XSA 0832	XSB 0832	7 1/2	31 1/2	8 x 32	7 1/2

When ordering separately, be sure to designate that mounting pan is for XIF series enclosure and specify size of box.